

# PR100

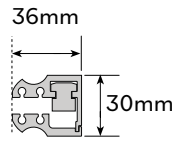

**Perfil parede**  
Wall profile  
Profil de mur



**Perfil chão**  
Floor profile  
Profil de sol

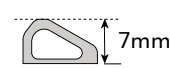

**Dobradiça**  
Hinge  
Charnière

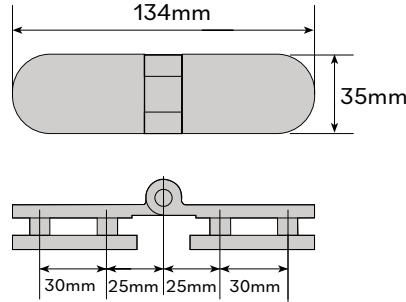

Aplicação a 10mm do rebordo da base  
Application 10mm edge of the base  
Application 10mm à partir du bord de la base.

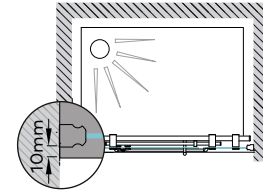

Accessórios em latão cromado.  
Fecho com pestana rígida.  
Vidro temperado de 8mm.  
Perfis em alumínio cromado.  
Altura standard: 2000mm.  
Porta com dimensões de 700mm.  
Largura mínima para fixo: 250mm.  
Dimensão máxima da porta 900mm.  
Dimensões não standard: sob consulta  
Informar se a montagem da cabine e numa base  
Definir medidas exactas na encomenda.

Brass fittings.  
Closure with rigid flap.  
8mm tempered glass.  
Aluminium profiles chromed.  
Standard height: 2000mm.  
Door with standard size: 700mm.  
Minimum size for fixed panel: 250mm.  
Maximum dimension of the door 900mm.  
Non standard dimensions: on request.  
Informe if the showerscreen will be fixed  
on a showertray  
Specify sizes on the order.

Acessoires en laiton chrome.  
Fermeture avec joint à rabat rigide.  
Verre trempé de 8mm.  
Profils en aluminium chrome.  
Hauteur standard: 2000mm.  
Porte avec taille standard de 700mm  
Largeur minimale pour panneau fixe: 250 mm.  
Dimension maximale de la porte 900mm  
Dimension non standard : Sur demande / Devis  
Informar si la paroi de douche sera installée sur un  
receveur  
Specifiez les mesures exactes lors de la commande.

## Tipologias

Typology Tipologias

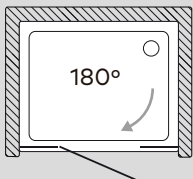
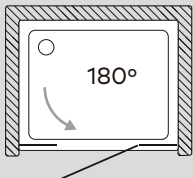

## Acabamentos

Finished. Acabamentos\*

Perfis . Profile. Profils



Cromado  
Chromed  
Chromé

Vidro . Glass. Verre



Transparente  
Black  
Noir

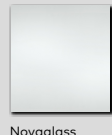

Novaglass  
Novaglass  
Opaque



Foscagem  
Sandblasting  
Sablage



Impressão digital  
Fingerprint  
Empreinte digitale



Ambientalmente Sustentável  
Environmentally Sustainable  
Écologiquement durable



Foscagem com tratamento anti-manchas  
Anti-stain treatment for sandblasting glass  
Sablage au traitement anti-taches



Por medida  
Custom-made  
Sur mesure



Vidro 8mm  
8mm glass  
Verre 8mm.



Tratamento anticalcário  
Treatment possibility  
Traitement anti calcaire

## Medidas Standard

Standard Dimensions  
Dimensions standard

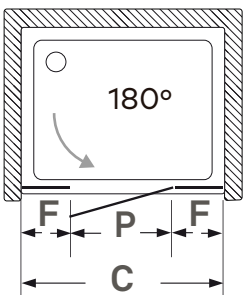

## Afinação

Adjustments  
Réglage

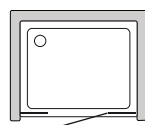

As medidas fornecidas devem ser resultantes da medição até à face exterior da base.

**Compensações feitas a cargo da ITALBOX.**

The provided dimensions should be measured to the outer face of the base.

**Adjustments made by ITALBOX.**

Les mesures fournies doivent être le résultat de la mesure entre murs.

**Décalages faites en charge de ITALBOX .**